

RIO

		
2000	1642	446

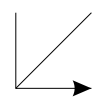

- (PL) Instrukcja montażu
- (CZ) Návod k montáži
- (D) Montageanleitung
- (GB) Assembly instruction
- (F) Model d'emploi
- (HU) Szerelési útmutató
- (I) Istruzione di montaggio
- (NL) Handleiding voor de montage

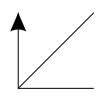
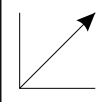
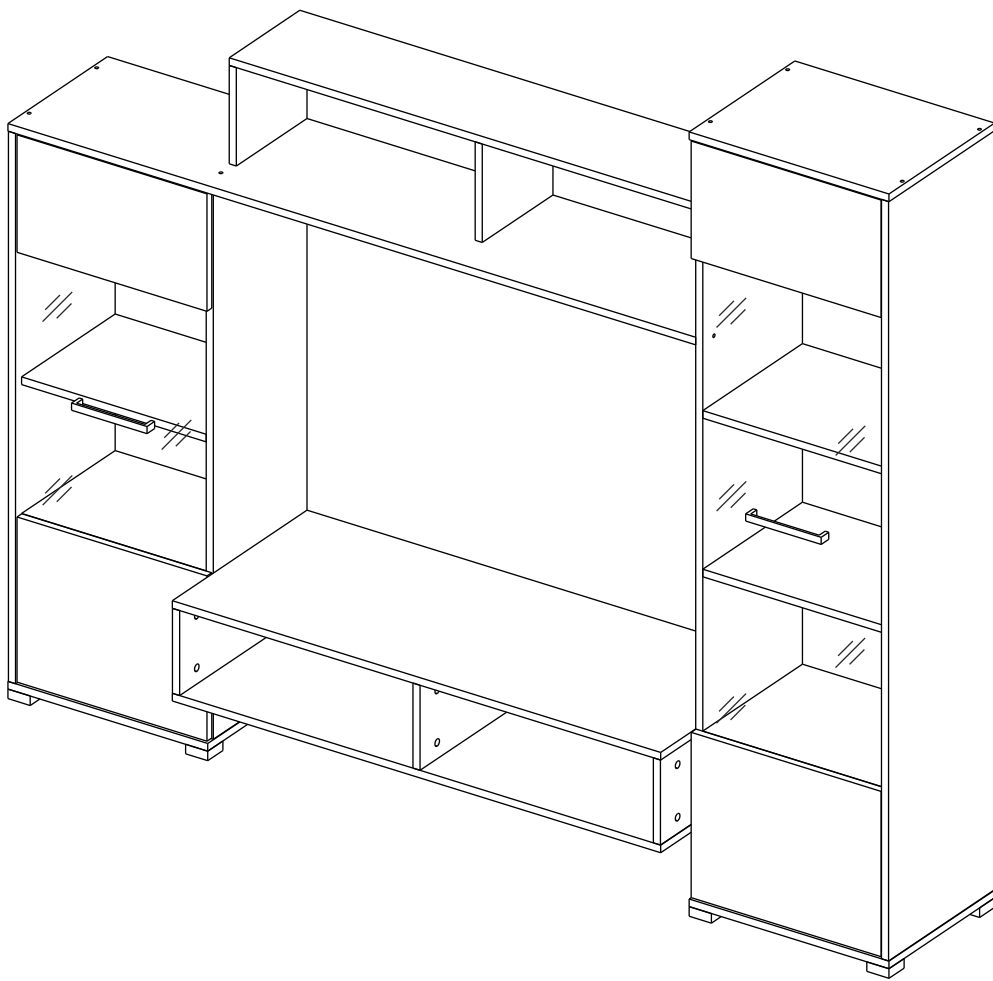
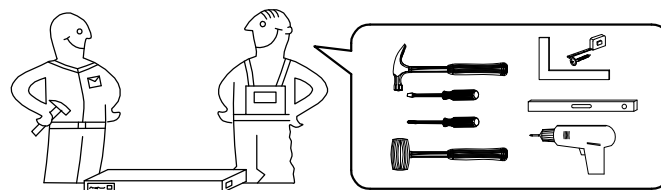

- (RU) Инструкция по монтажу
- (RO) Instrucțiuni de montare
- (SK) Návod k montáži
- (TR) Montaj talimatı

Uwaga • Upozornění • Achtung • Attention • Caution • Figyelem Attenzione • Opgelet • Внимание • Atenție • Upozornenie • Dikkat	
PL	Czyszczenie należy wykonać wyłącznie za pomocą ściereczki lub lekko nawilżonego ręcznika. Nie stosować środków czyszczących do szorowania.
CZ	Čistění je nutné vykonávat výhradně pomocí utěrky nebo lehce navlhčeného ručníku. Nepoužívejte čisticí prostředky obsahující abrazivní částice.
D	Bitte nur mit einem Staubtuch oder leicht feuchtem Lappen reinigen. Keine scheuernden Putzmittel verwenden.
GB	Please only clean with a duster or a damp cloth. Do not use any abrasive cleaners.
F	Le nettoyage se fait uniquement à l'aide d'un torchon ou d'une serviette légèrement mouillée.
HU	A tisztítás kizárólag törölőruha vagy enyhén nedvesített törölköző segítségével végezhető. Súroló hatású tisztítószereket nem szabad használni.
I	Pulire esclusivamente con un panno o un asciugamano umido.
NL	Reinig alleen met een stofdoek of een lichtjes vochtige doek. Gebruik geen schurende poetsmiddelen.
RU	Очищайте от пыли тряпкой или слегка влажной ветошью. Не допускается применение чистящих средств, не предназначенных для ухода за мебелью.
RO	Curățarea trebuie efectuată numai cu o cârpă sau cu un prosop ușor umezit. Nu utilizați agenți de curățare abrazivi.
SK	Čistení je nutné vykonávať výhradne pomocí utierky alebo ľahko zvlhnutým ručníkom. Nepoužívajte čistiace prostriedky obsahujúce abrazívne častice.
TR	Lütfen sadece bir toz bezilye veya hafif nemli yumuşak bir bezle siliniz. Aşındırıcı temizlik malzemeleri kullanmayınız.

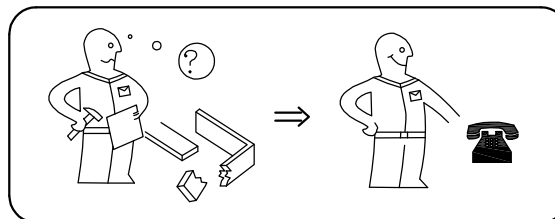
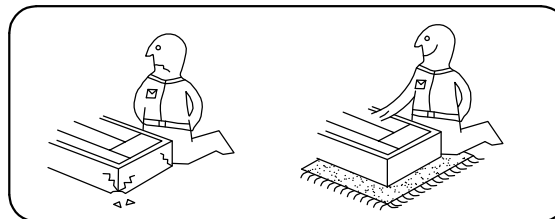



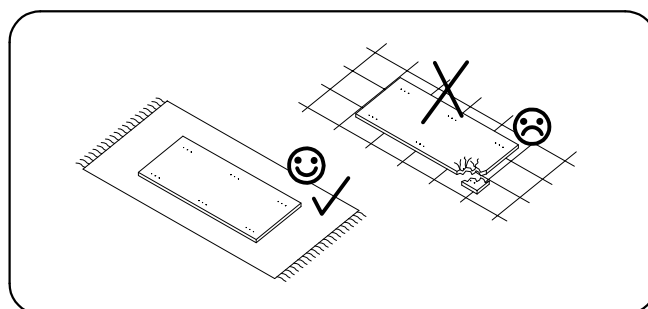
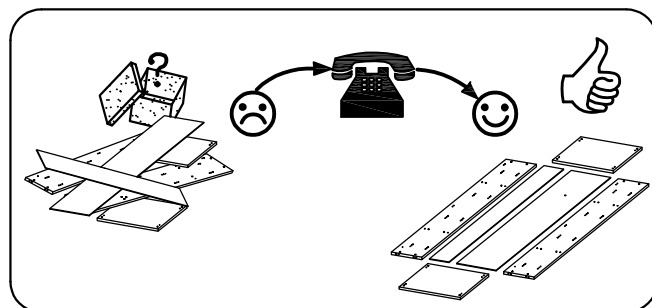
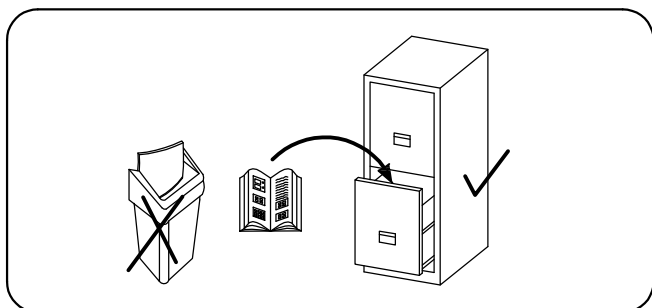





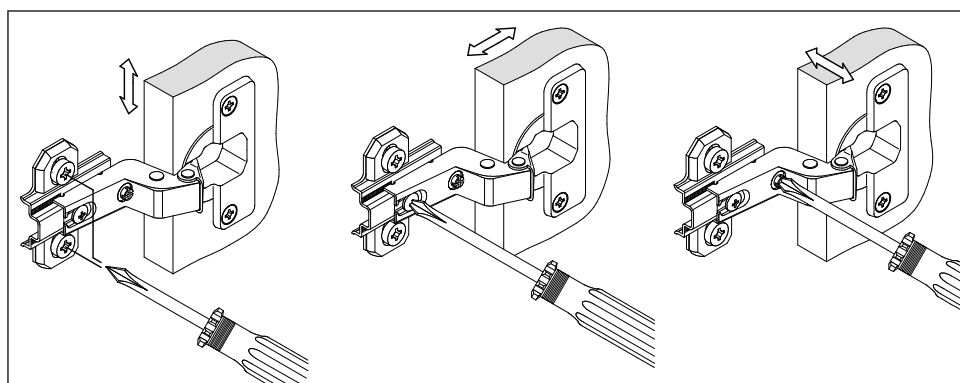

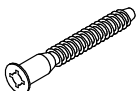

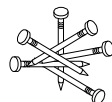

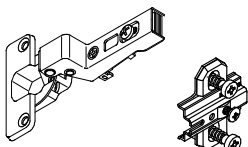
Karta serwisowa • Servisní list • Service Karte • Service card • Carte de service • Szervizkártya
Scheda di servizio • Service kaart • Сервисная карта • Fisa service • Servisný list • Servis karti

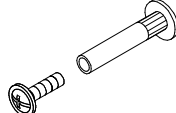

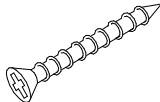
Комплектовочная ведомость / Set package sheet

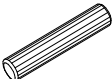
Упаковка / Pack	Наименование	Description	Цвет / Décor	Размер/ Size, мм	Кол-во/ Quantity, шт.	№
			Canter-Sonoma			
1	Фурнитура	Furniture/Cabinetry hardware			1	
2	Боковина правая	Side right	Sonoma	1152x310	1	2
	Боковина левая	Side left	Canter	1152x330	1	3
	Боковина левая	Side left	Sonoma	1590x330	1	4
	Боковина правая	Side right	Canter	1590x350	1	5
	Крыша	Top	Canter	1116x234	1	10
	Крыша	Top	Canter	1549x330	1	11
	Фасад левый	Door left	Sonoma	428x346	1	16L
	Фасад правый	Door right	Sonoma	428x346	1	16R
3	Боковина	Side	Canter	206x234	2	1
	Боковина	Side	Canter	178x446	3	6
	Крыша	Top	Canter	1100x446	2	7
	Крыша	Top	Canter	450x330	1	8
	Крыша	Top	Canter	450x350	2	9
	Полка	Shelves	Canter	416x310	3	12
	Полка	Shelves	Canter	416x330	4	13
	ХДФ	Back element	Sonoma	252x446	2	18
	ХДФ	Back element	Sonoma	1008x446	1	19
	ХДФ	Back element	Sonoma	352x446	1	20
	ХДФ	Back element	Sonoma	924x446	1	21
	Фасад левый	Door left	Sonoma	428x246	1	17L
	Фасад правый	Door right	Sonoma	428x246	1	17R
4	Стекло	Glass	Прозрач/transparent	604x411	1	22
	Стекло	Glass	Прозрач/transparent	1042x411	1	23

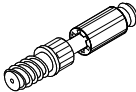

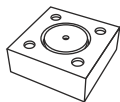
5	7x50	6	6,3x10,5	13	4x16	48	2x20	15	
									
20 x		16 x		28 x		50 x		1 x	
90		108	C19 160	72		9		39	
									
8 x		2 x		20 x		4 x		28 x	
14	4x30	75	for 7	7	8x30	45		21	
									
8 x		1 x		4 x		4 x		12 x	
1		2		73		38			
									
16 x		16 x		12 x		8 x			

